



Product Description

The KBC FDVA4 series uses the most advanced digital technologies to provide excellent repeatable performance for today's CCTV systems. It supports transmission of four analog composite video channel over one multimode or singlemode optical fiber. PAL, NTSC and SECAM video standards are fully supported. The plug-and-play design ensures ease of installation with no electrical or optical adjustment needed. LED indicators are provided to show the operational status of the unit clearly. The series is available in compact wall-mount or 3U chassis card.



Product Features

- 8 or 10 bit digitally-encoded, non-compressed video transmission
- Multimode and singlemode solutions
- Card module requires just 1 slot of 3U chassis
- LED indicators provide quick diagnosis of all important system parameters
- Wall-mount and 3U chassis card configurations
- Wide optical dynamic range. No adjustment required

Typical System Configuration

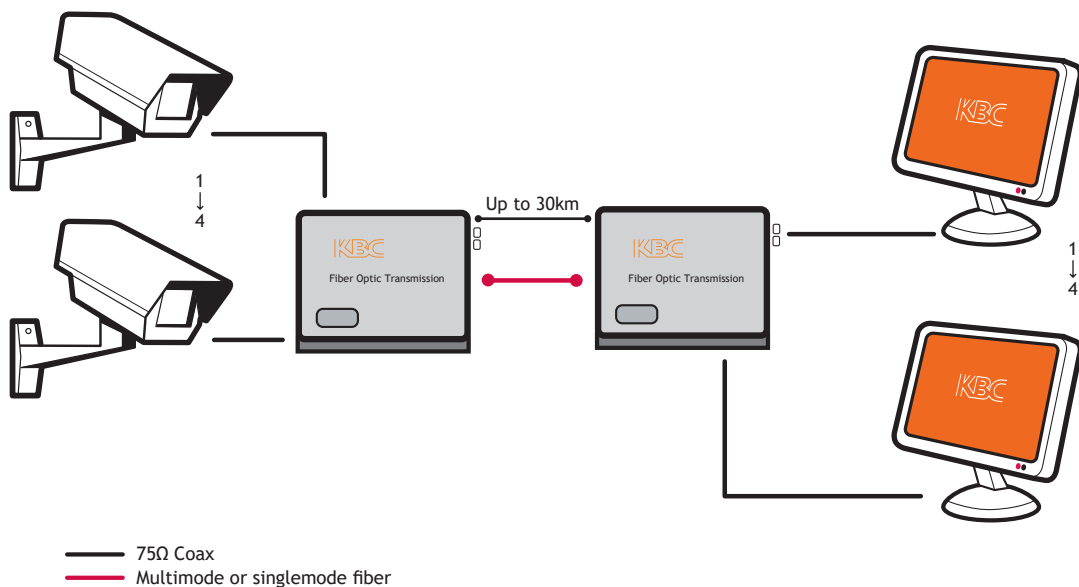

Specifications

Video

No. of Channels per Module	4	
Format	PAL / NTSC / SECAM	
Input/Output	1.0V pk-pk typical, 75Ω	
Bandwidth	5 Hz ~ 6.5 MHz	
Digital Encoding (non Compressed)	8 bit	10 bit
Differential Gain (10-90% APL)	<2%	<2%
Differential Phase (10-90% APL)	<2°	<0.7°
Signal to Noise Ratio (SNR) weighted	>60dB	>67dB

Optical

Wavelength	1310nm
Number of Fibers	1
Fiber	Multimode or Singlemode

Power

Power Input (Wall-mount)	+12 -24 Vac/dc@ 400mA
Power Supply(1)	Input: 100 ~ 240 Vac Output: +12 Vdc UL and cUL listed PSU Supplied from FR3 PSU
Chassis Card	

Environmental

Operating Temperature	-40° ~+74° C / -40° ~+165° F
Storage Temperature	-40° ~+74° C / -40° ~+165° F
Operating Humidity	0 to 95% non-condensing
Mean Time Between Failure (MTBF)	>100,000 Hours

Mechanical

Dimensions (Wall-mount L x W x H) ⁽⁵⁾	223mm x 158mm x 36mm (8.78" x 6.22" x 1.42")
Number of 3U Chassis Card Slots ⁽²⁾	1

Connectors

Video	BNC 75Ω
Fiber	ST, SC or FC (ST fitted as standard)
Power ⁽³⁾	Screw Block Terminal (Wall-mount)

Part Number Configurator

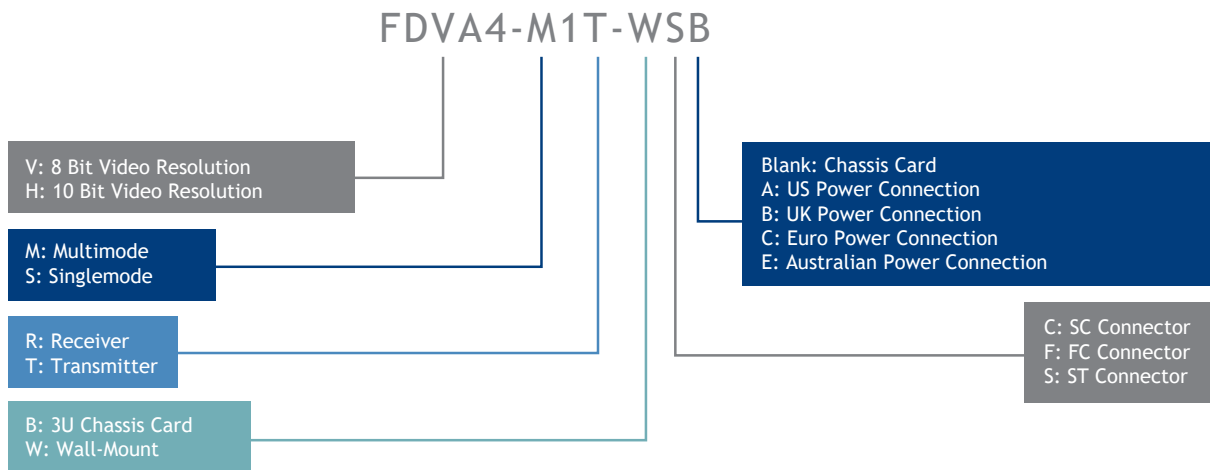

Optical Budget

Part Code	Fiber Type	No.	Optical Budget			Wavelength nm	Approximate Transmission Distance(4)
			50µm	62.5µm	9µm		
FDVA4-M*	Multimode	1	8dB	12dB		1310	0-4km
FDVA4-S*	Singlemode	1			15dB	1310	0-30km

Transmission distances up to 120km are available please contact KBC Networks for details. All KBC Networks optical transmitters are LASER based.

1. Please select the power plug from US Standard, Euro 2 Circular or UK 3 Pin square when placing order.
2. Supports maximum of up to 14 single slot cards in each 3U Chassis.
3. Power lines are crimped and fitted to screw block connector in factory.
4. Transmission distance is limited by optical loss of the fiber and loss introduced by connectors, splices and patch panels. Fiber bandwidth also limits the transmission distance.
5. Product body dimensions. Please contact KBC Networks for product drawing and dimensions of mount.

Due to ongoing technological improvements, product specifications are subject to change without notice. KBC is not liable for any errors, omissions or changes of any description of the goods contained herein. This information is for the sole purpose of identifying the products, and KBC makes no warranty that the products conform to any description contained herein. Do not rely solely on any representations, statements, or assertions concerning these Products contained herein.